

**msi**

# GT780DX info kit

Edited by: Koen Coppens

Version: 1.3



**msi**

**WHO WILL YOU BECOME?**

**msi™**

**What gamers say...**

***“Having the most powerful gear is a must when it comes to competitive gaming. You need a system that can run the highest frame rates, and a design and layout that suits gamers’ needs. The gaming laptop is something we use in our homes when practicing, but also on the road when we participate in tournaments, therefore it’s extremely important that our laptops have the best quality out there.”***

Patrik ‘**cArn**’ Sattermon,  
Counterstrike Team leader *Fnatic.MSI*



***MSI, Brand for Gamers.***

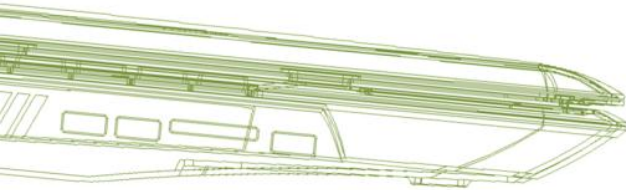

The design concept is based around **less curves with crisp lines**. **Brushed aluminum finish** for strength and style, but also a more robust chassis from a technical point of view.

Full black was a must with a **backlight logo** to reinforce gamer identity.



## Keyboard by steelseries





- First priority  The most used gaming keys (W, A, S, D, Ctrl and Space)
- 2<sup>nd</sup> priority  The second priority gaming keys
- 3<sup>rd</sup> priority  The third priority gaming keys



## Keyboard by steelseries



- First priority  The most used gaming keys (W, A, S, D, Ctrl and Space)
- 2<sup>nd</sup> priority  The second priority gaming keys
- 3<sup>rd</sup> priority  The third priority gaming keys





# Multi-color backlight design

Keyboard by

# steelseries



## Full Color Programmable Backlight

Choose from more than 1,000 display combinations and 5 programmable scenario modes with the Keyboard LED Manager (KLM).



### 1. NORMAL MODE:

Colors chosen by the user can be applied to the whole keyboard; different colors can be set for the three different sections.



### 2. GAMING MODE:

Only the LEDs on the left remain enabled. A choice of 29 colors is available.



### 3. BREATHING MODE:

The alternating bright and dim appearance of the selected color creates a pulsating breathing effect.

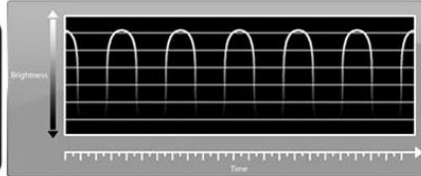

### 4. WAVE MODE:

This creates an effect reminiscent of "the wave" by fans in a stadium. The LEDs alternate between the selected color and darkness in a gradation which flows from right to left.

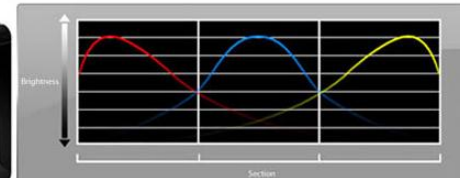

### 5. DUAL COLOR MODE:

The whole keyboard LEDs alternate between two selected colors in a gradient mode.

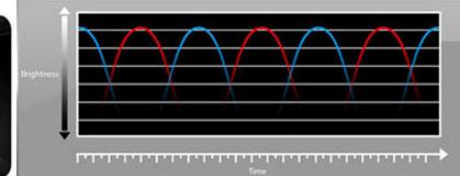



Questions to  
Patrik “**cArn**” Sattermon,  
Counterstrike Team leader *Fnatic.MSI*

## **MSI : What do you think about GT780DX SteelSeries keyboard?**

*“As a gaming laptop has limited space to fit in a keyboard, I think simplicity is the only way to go. The MSI GT780DX keyboard has **highlighted and enlarged the buttons that the majority of gamers use.** The **function and windows button is conveniently relocated** and smaller than the standard laptop keyboards.”*

## **MSI : Why is it important to have a good keyboard layout?**

*“In some of the games a player can have up to 400 actions per minutes, this means a keyboard has to be very distinct so the player can **easily find the desired key** he/she want to press. Also, the majority of gamers have a background using desktop PC with the full-sized keyboard, therefore it's important that the gaming laptop keyboard's design reminds you of a full-size keyboard.”*



# Gamers' opinion – Non-glare panel



- **The screen is the eyes of the gamer**  
MSI therefore has chosen the highest quality of panel available for GT780DX.
- **Non-Glare filter**  
You can play in any condition inside or outside without being distracted by reflections
- **LED backlight**  
For superior image quality, and longer battery life
- **Full HD**  
Accurately displays the detail of latest games, with no loss of quality when watching Blu-ray movies



## Why is it important to have a non-glare panel during competition?

*"Besides the powerful system you also need a screen that **displays the in-game images as clearly and as fast as possible**. If your screen is not very visible you will lose time to react during battle, and even the smallest delay can cause big setbacks."*





# Comparison between DVD and Blu-Ray



## Sound by **DYNAUDIO**

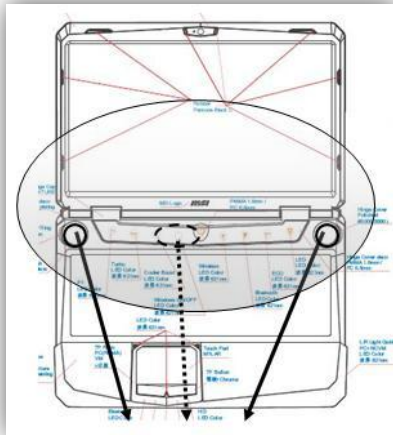

- Dynaudio designs customized speakers, inspired by their high end audio range. The whole electronics circuit have been redesigned to offer **more realistic sound with high fidelity**. Every detail created by the game designers will be **played back with impressive precision**.
- With THX TruStudio PRO, movies and games can be experienced in a **real-life surround sound experience**.

*-Trying the MSI G-series notebook range with Dynaudio & THX sound is an experience you will never forget!-*



### Why is it important to have a very good sound when playing games?

*"In FPS-games the sound is used to **detect your enemies**, along with your vision on your screen plus the in-game communication tool you and your teammates are using. Besides having great in-game sound I also find it important to have powerful speakers that you can **use for multimedia, such as movies and music.**"*



*“The NVIDIA® GeForce® GTX 570M, up to 34% faster than the previous generation, lets you play the latest games at HD resolutions”*

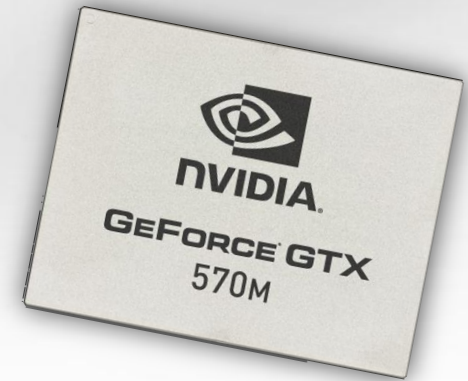
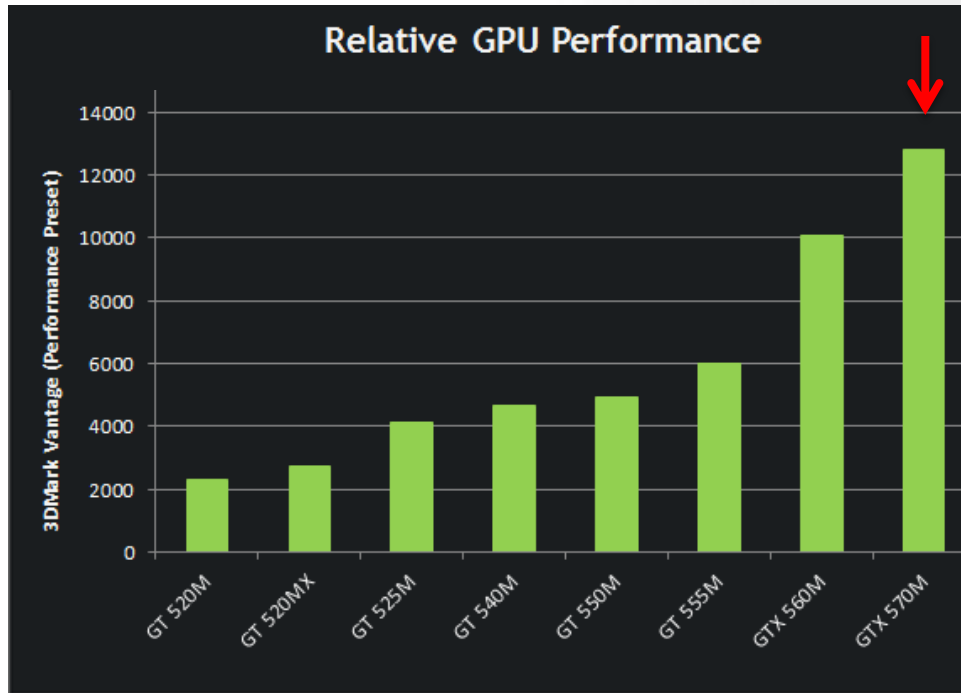

#### Supported Technologies

- ✓ 3D Vision
- ✓ CUDA
- ✓ DirectX 11
- ✓ PhysX
- ✓ SLI





*“Get amazing visual quality, improved efficiency and dramatic gaming performance for today and tomorrow with support for Microsoft® DirectX® 11”*



## DX11: Tessellation

- Characters with **beautiful curves**
- **Super detailing** of surfaces such as thorns, nails and skin.
- **Fast rendering** of geometric areas with large amounts of information.
- **Seamless transitions** between surfaces

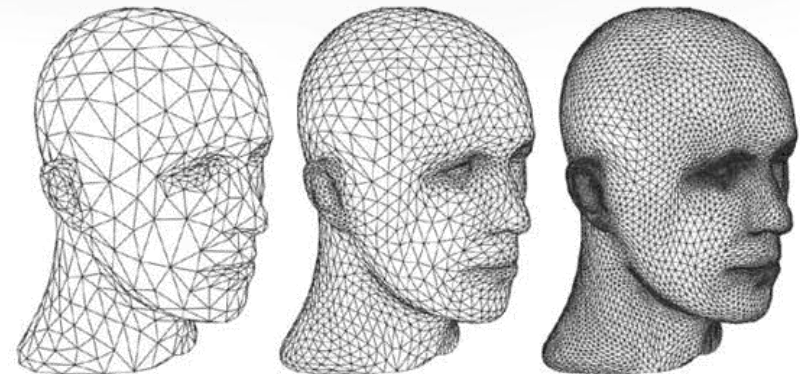

[NVIDIA - Tessellation: Hair Demo](#)

Microsoft®  
DirectX®11



“NVIDIA® PhysX® technology adds an *element of realism* never before seen in gaming.”



## NVIDIA® PhysX®

With an NVIDIA® GeForce® GPU in your PC, experience dynamic PhysX® effects:

- Blood Spatter
- Interactive smoke
- Splashing debris
- Wavy effect of clothing
- Etc ...



[NVIDIA – PhysX: Mafia II Demo](#)

The GT780DX is the perfect gaming notebook for the current...

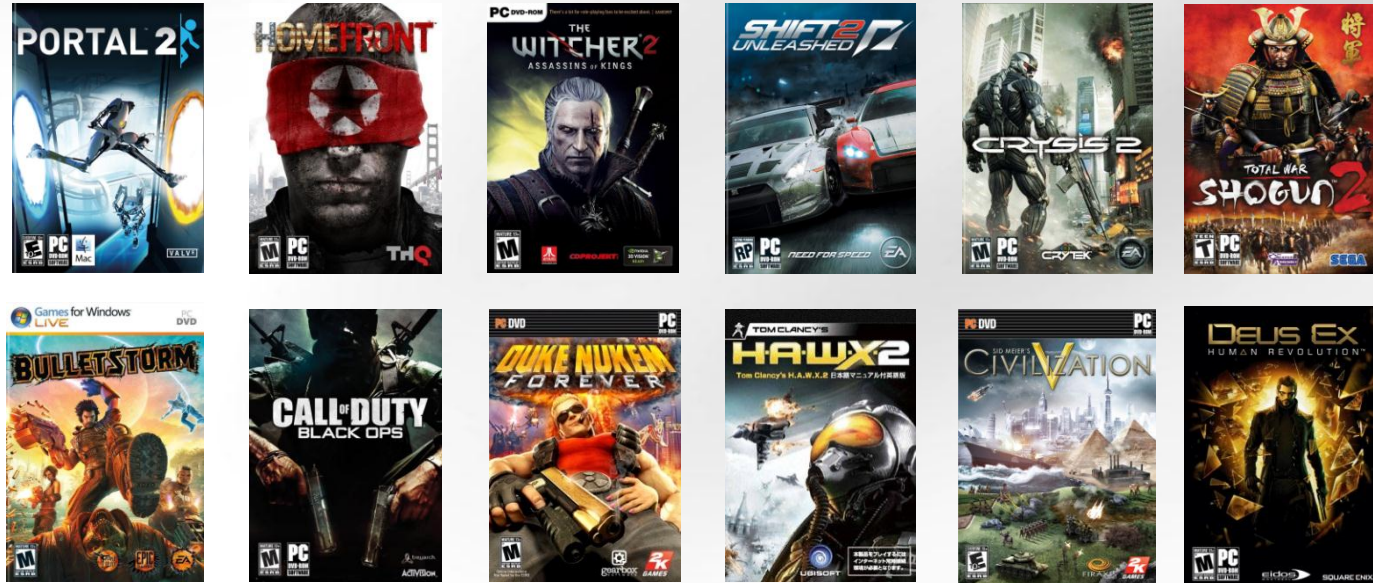

...and upcoming blockbuster games!



**msi**

Ready for next-gen games

The MSI GT780DX: optimal gaming experience in this years blockbuster games!

The Elder Scrolls V  
SKYRIM

CALL OF DUTY  
MW3

BATTLEFIELD  
3



**msi**

# Turbo Drive Engine technology

**Extra performance boost with one push on the Turbo button!**



## ONE-TOUCH OVERCLOCKING WITH MSI TURBO DRIVE ENGINE (TDE) TECHNOLOGY

MSI Turbo Drive Engine (TDE) Technology is the world's No.1 turbo technology. With MSI TDE Technology, you can experience faster response time and efficient real-time data processing.

*\*Test results may vary under different testing environments.*





*-Please check your local SKU!-*

## *SKU with two HDD - GT780DXR*

- **RAID 0:** MSI uses RAID 0 on high performance NB's like GT780DX to boost up the HDD writing & reading speed up-to 2 times.



Dual HDD

## *SKU with SSD - GT780DX*

- **SSD on GT780DX** gives an enormous performance boost and is more Silent, Faster, Smaller, Lighter, and uses less Power.
- **Combined with HDD** for massive storage for all your movies, music and games.

**-Please check your local SKU!-**

Model	MSI GT780DX	Axxx G74SX
Display	17.3" FHD (1920x1080) or HD+ (1600x900) LED Backlight	17.3" FHD (1920x1080) or HD+ (1600x900) or FHD 3D (1920x1080) LED Backlight
None Glare LCD	Yes	N/A
Graphics	1.5GB GTX570M	2GB/3GB GTX560M
Graphic Overclocking	Yes (TDE GPU) - 5% Over Clock	N/A
DRAM max	8GB (up to 16GB)	16GB
Dual HDD RAID	Yes (HM67 Chipset) RAID HDD Faster 80% ( Read/Write ) for standard HDD	No (HM65 Chipset)
Keyboard	SteelSeries Co-branding Full-color backlight with Exclusive KLM SteelSeries Desktop Keyboard cost 100USD	Standard Notebook Keyboard White backlight only
ID, Material & Body	Metal, NEW design!	Plastic
Audio	Dynaudio (Hi-Fi) Certificated Speaker 2.1 channel  THX TruStudio Pro 4 audio jack for 7.1ch output	IT Branding Speaker 2.1 channel 2 audio jack THX TruStudio EAX Advanced HD 5.0
Webcam	HD 30fps	HD 30fps
Battery	9 Cells 7800 mAh 87Wh	8 Cells 5200 mAh 74Wh
USB 3.0 / USB 2.0 / eSATA	2 Ports / 3 Ports / 1 Port	1 Port / 3 Ports / N/A
Output displays	HDMI & D-Sub	HDMI
Weight	3,9Kg	4,28Kg
Benchmark results	3DMark Vantage: P9290 (P9587 with TDE on) 3DMark11: P2033 (P2097 with TDE on)	3DMark Vantage: P9180 3DMark11: P2008

**Even if the 570M has less memory it will end up to 34% faster compared to the 560M!**

This is because the 560M only has 192 cuda cores, but the 570M has 336 cuda cores.

*-Please check your local SKU!-*

<b>CPU</b>	<b>Intel® Core™ i7-2630QM / i5-2410M</b>
<b>Operating system</b>	<b>Genuine Microsoft® Windows® 7 Home Premium 64 Bit</b>
<b>Graphics</b>	<b>NVIDIA® GeForce™ GTX570M 1.5GB GDDR5</b>
<b>RAM</b>	<b>8GB/16GB DDR3</b>
<b>HDD</b>	<b>500GB/750GB/1.5TB 7200rpm (with Raid 0)</b>
<b>Display</b>	<b>17" 16:9, 1920 x 1080, Full-HD non-glare</b>
<b>Chipset</b>	<b>Intel® HM67 Express</b>
<b>Optical Drive</b>	<b>Super Multi/Blu-ray</b>
<b>I/O</b>	<b>HDMI, VGA Out, 2x USB3.0, 3x USB2.0, 1x eSATA</b>
<b>Wireless</b>	<b>802.11 b/g/n</b>
<b>Cardreader</b>	<b>7-in-1</b>
<b>Sound</b>	<b>7.1 surround sound with Dynaudio &amp; THX TruStudioPRO™</b>
<b>Web-cam</b>	<b>HD Web-cam (2MP with HD video)</b>
<b>Dimensions(mm)</b>	<b>428 x 288 x 55 mm</b>
<b>Weight(kg)</b>	<b>3.9 kg</b>
<b>Keyboard</b>	<b>SteelSeries Gaming Keyboard</b>



# Other features

- Four SO-DIMM slots with up to 16 GB storage capacity
- Easy upgrade to accelerate the notebook processing speed



## USB 3.0

10X faster copying an 25GB HD movie in 70 seconds

- 10X higher data transfer rates (4.8 Gbps) than USB 2.0

Compatible to the future high speed CE devices



- Cooler Boost cools the CPU and GPU faster to decrease the fan speed by giving real-time notification of the MSI notebook's core temperature variations and fan speed

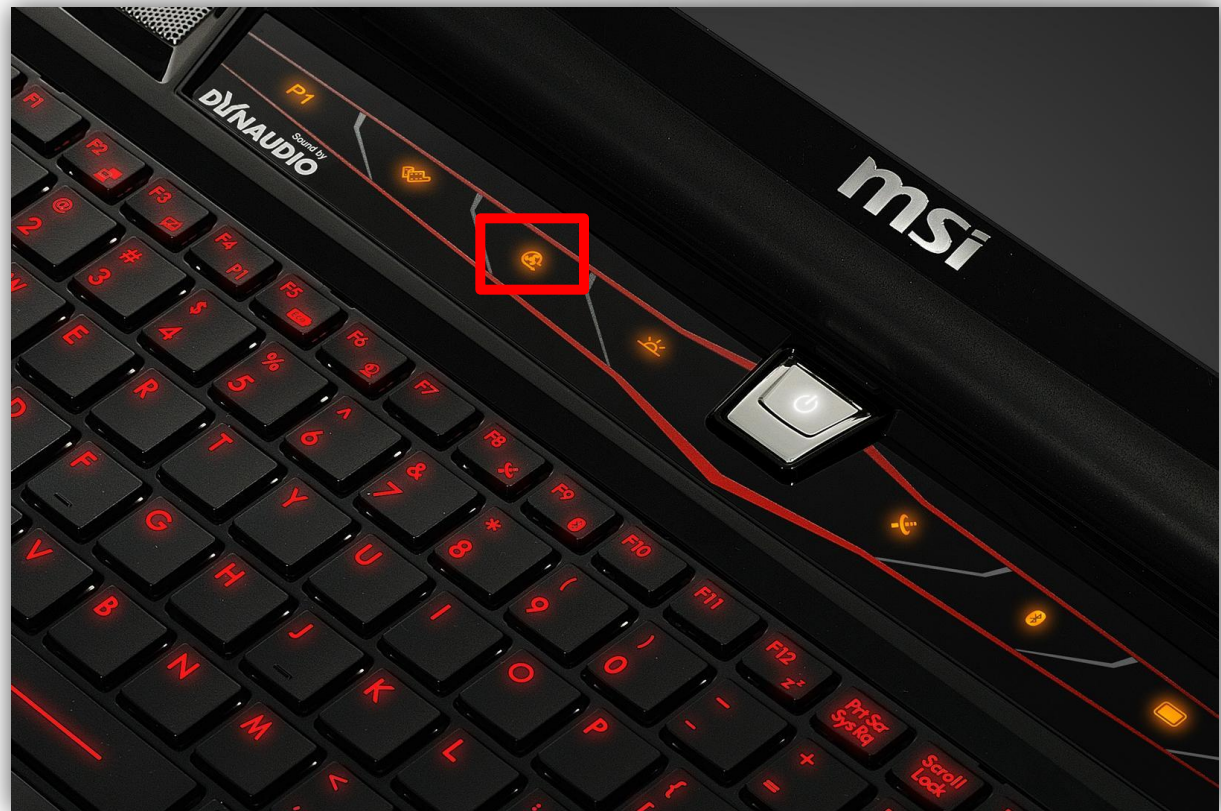



HD Webcam



**Legacy Webcam**  
8 frames per second face to face talk.



**HD Webcam**  
1280x720 (720p) @ 30fps smooth  
video capture and face to face talk.



- MSI i-Charger allows you to use your laptop as a battery extender, charging your iPod / iPad / Android device when your laptop is powered down!
- Click the i-Charger software to Connect right USB device to charge.  
**3x faster charge speed** than normal USB2.0.



# MSI GT780DX

MSI GT780DX = MSI GT780 + 570M (+ SSD)

*GT780DX: The most powerful gear for competitive gaming!*



**msi**™

CALL OF DUTY  
SKYRIM The Elder Scrolls V MW3 BATTLEFIELD 3

