

MS-7501M1 (V2.X) Mainboard



Copyright Notice

The material in this document is the intellectual property of the company. We take every care in the preparation of this document, but no guarantee is given as to the correctness of its contents. Our products are under continual improvement and we reserve the right to make changes without notice.

Trademarks

All trademarks are the properties of their respective owners.

Intel® and Pentium® are registered trademarks of Intel Corporation.

AMD, Athlon™, Athlon™ XP, Thoroughbred™, and Duron™ are registered trademarks of AMD Corporation.

NVIDIA, the NVIDIA logo, DualNet, and nForce are registered trademarks or trademarks of NVIDIA Corporation in the United States and/or other countries.

PS/2 and OS®/2 are registered trademarks of International Business Machines Corporation.

Windows® 95/98/2000/NT/XP are registered trademarks of Microsoft Corporation.

Netware® is a registered trademark of Novell, Inc.

Award® is a registered trademark of Phoenix Technologies Ltd.

AMI® is a registered trademark of American Megatrends Inc.

Revision History

Revision	Revision History	Date
V2.0	First release	April 2008

Technical Support

If a problem arises with your system and no solution can be obtained from the user's manual, please contact your place of purchase or local distributor. Alternatively, please try the following help resources for further guidance.

Safety Instructions

1. Always read the safety instructions carefully.
2. Keep this User's Manual for future reference.
3. Keep this equipment away from humidity.
4. Lay this equipment on a reliable flat surface before setting it up.
5. The openings on the enclosure are for air convection hence protects the equipment from overheating. **DO NOT COVER THE OPENINGS.**
6. Make sure the voltage of the power source and adjust properly 110/220V before connecting the equipment to the power inlet.
7. Place the power cord such a way that people can not step on it. Do not place anything over the power cord.
8. Always Unplug the Power Cord before inserting any add-on card or module.
9. All cautions and warnings on the equipment should be noted.
10. Never pour any liquid into the opening that could damage or cause electrical shock.
11. If any of the following situations arises, get the equipment checked by service personnel:
 - ▶ The power cord or plug is damaged.
 - ▶ Liquid has penetrated into the equipment.
 - ▶ The equipment has been exposed to moisture.
 - ▶ The equipment does not work well or you can not get it work according to User's Manual.
 - ▶ The equipment has dropped and damaged.
 - ▶ The equipment has obvious sign of breakage.
12. **DO NOT LEAVE THIS EQUIPMENT IN AN ENVIRONMENT UNCONDITIONED, STORAGE TEMPERATURE ABOVE 60°C (140°F), IT MAY DAMAGE THE EQUIPMENT.**



CAUTION: Danger of explosion if battery is incorrectly replaced. Replace only with the same or equivalent type recommended by the manufacturer.



廢電池請回收

For better environmental protection, waste batteries should be collected separately for recycling or special disposal.

FCC-B Radio Frequency Interference Statement

This equipment has been tested and found to comply with the limits for a Class B digital device, pursuant to Part



15 of the FCC Rules. These limits are designed to provide reasonable protection against harmful interference in a residential installation. This equipment generates, uses and can radiate radio frequency energy and, if not installed and used in accordance with the instructions, may cause harmful interference to radio communications. However, there is no guarantee that interference will not occur in a particular installation. If this equipment does cause harmful interference to radio or television reception, which can be determined by turning the equipment off and on, the user is encouraged to try to correct the interference by one or more of the measures listed below.

- ▶ Reorient or relocate the receiving antenna.
- ▶ Increase the separation between the equipment and receiver.
- ▶ Connect the equipment into an outlet on a circuit different from that to which the receiver is connected.
- ▶ Consult the dealer or an experienced radio/television technician for help.

Notice 1

The changes or modifications not expressly approved by the party responsible for compliance could void the user's authority to operate the equipment.

Notice 2

Shielded interface cables and A.C. power cord, if any, must be used in order to comply with the emission limits.

VOIR LA NOTICE D'INSTALLATION AVANT DE RACCORDER AU RESEAU.



This device complies with Part 15 of the FCC Rules. Operation is subject to the following two conditions:

- (1) this device may not cause harmful interference, and
- (2) this device must accept any interference received, including interference that may cause undesired operation.

CONTENTS

Copyright Notice	ii
Trademarks	ii
Revision History	ii
Technical Support	ii
Safety Instructions	iii
FCC-B Radio Frequency Interference Statement	iv
Chapter 1 Getting Started	1-1
Mainboard Specifications	1-2
Chapter 2 Hardware Setup	2-1
Mainboard Layout	2-2
CPU (Central Processing Unit)	2-3
Memory	2-6
Power Supply	2-8
Back Panel	2-9
Connector	2-11
Slot	2-18
Jumper	2-19

Chapter 1

Getting Started

Thank you for choosing the MS-7501M1 (V2.X) Micro-ATX mainboard. The MS-7501M1 (V2.X) is based on AMD® RS780 & SB700 chipsets for optimal system efficiency. Designed to fit the advanced AMD® Phenom/ Athlon 64/ Sempron processors in Socket AM2/ AM2+, the MS-7501M1 (V2.X) delivers a high performance and professional desktop platform solution.

Mainboard Specifications

Processor

- Supports 95W AMD® Phenom/ Athlon 64/ Sempron processors
- Supports 4-pin CPU fan pinheader with Fan Speed Control

FSB

- Hyper Transport supports up to 2.6GHz

Chipset

- North Bridge: AMD® RS780
- South Bridge: AMD® SB700

Memory

- DDR2 533/ 667/ 800/ 1066 SDRAM (240 pins/ 1.8V)
- 4 DDR2 DIMM slots (8GB Max)

LAN

- Gigabit Fast Ethernet by Realtek® RTL8111C

IEEE 1394

- Chip integrated by JMicron® JMB381
- Transfer rate is up to 400Mb/s

Audio

- Chip integrated by Realtek® ALC888S-VC
- Flexible 8-channel audio with jack sensing
- Compliant with Azalia 1.0 Spec

IDE

- 1 IDE port by AMD® SB700
- Supports Ultra DMA 33/ 66/ 100/ 133 mode
- Supports PIO, Bus Master operation mode

SATA

- 6 SATA II ports by AMD® SB700
- Supports storage and data transfers at up to 3.0Gb/s

Floppy

- 1 floppy port
- Supports 1 FDD with 360KB, 720KB, 1.2MB, 1.44MB and 2.88MB

Connectors

● **Back Panel**

- 1 PS/2 mouse port
- 1 PS/2 keyboard port
- 1 LAN jack
- 4 USB ports
- 5 audio jacks
- 1 optical S/PDIF-out jack
- 1 IEEE 1394 port (Optional)

● **On-Board Pinheader/ Connector**

- 3 USB pinheaders
- 1 CD-in connector
- 1 IEEE 1394 pinheader (Optional)
- 1 serial port connector
- 1 front panel audio pinheader
- 1 chassis intrusion switch pinheader
- 1 S/PDIF-out pinheader (for HDMI Audio)
- 1 VFD connector
- 1 SMI switch
- 1 scart audio

Slots

- 1 PCI Express x16 slot
- 1 PCI Express x1 slot
- 1 32-bit/ 33MHz PCI white slot, single master
- 1 32-bit/ 33MHz PCI blue slot, double master

Form Factor

- Micro-ATX (24.4cm X 24.4 cm)

Mounting

- 6 mounting holes

Chapter 2

Hardware Setup

This chapter provides you with the information about hardware setup procedures. While doing the installation, be careful in holding the components and follow the installation procedures. For some components, if you install in the wrong orientation, the components will not work properly. Use a grounded wrist strap before handling computer components. Static electricity may damage the components.

Mainboard Layout

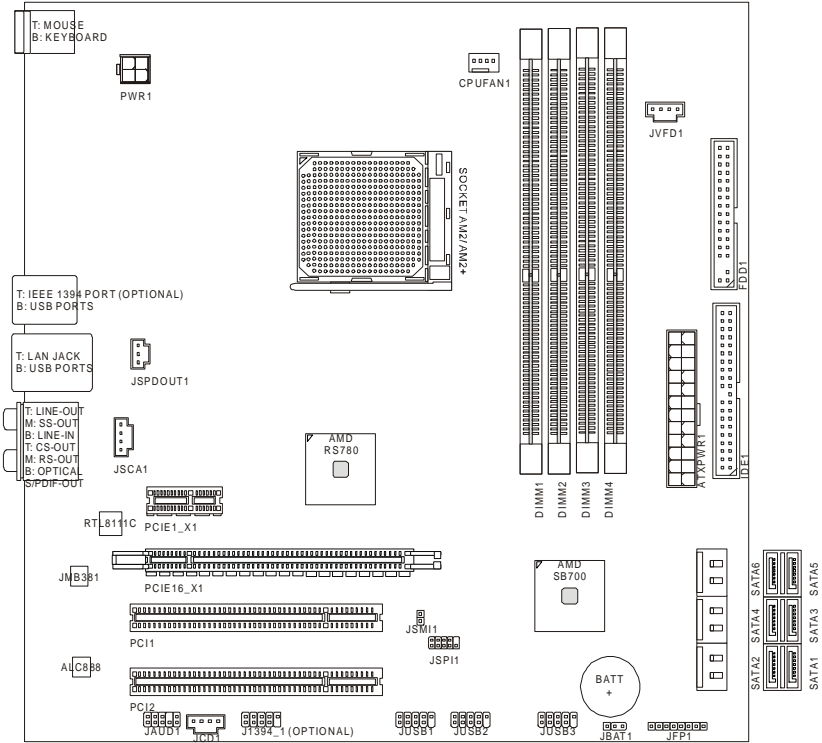

MS-7501M1 (V2.X)
Micro-ATX Mainboard

CPU (Central Processing Unit)

The mainboard supports 95W AMD® Phenom/ Athlon 64/ Sempron processors in Socket AM2/ AM2+. The Socket AM2/ AM2+ offers easy CPU installation. When you are installing the CPU, make sure the CPU has a heat sink and a cooling fan attached on the top to prevent overheating. If you do not have the heat sink and cooling fan, contact your dealer to purchase and install them before turning on the computer.



Important

Overheating

Overheating will seriously damage the CPU and system. Always make sure the cooling fan can work properly to protect the CPU from overheating. Make sure that you apply an even layer of thermal paste (or thermal tape) between the CPU and the heatsink to enhance heat dissipation.

Replacing the CPU

While replacing the CPU, always turn off the power supply or unplug the power supply's power cord from the grounded outlet first to ensure the safety of CPU.

Overclocking

This mainboard is designed to support overclocking. However, please make sure your components are able to tolerate such abnormal setting, while doing overclocking. Any attempt to operate beyond product specifications is not recommended. We do not guarantee the damages or risks caused by inadequate operation or beyond product specifications.

CPU Installation Procedures for Socket AM2/ AM2+

1. Please turn off the power and unplug the power cord before installing the CPU.
2. Pull the lever sideways away from the socket. Make sure that you raise the lever up to a 90-degree angle.
3. Look for the gold arrow on the CPU. The gold arrow should point as shown in the picture. The CPU can only fit in the correct orientation. Lower the CPU down onto the socket.
4. If the CPU is correctly installed, the pins should be completely embedded into the socket and can not be seen. Please note that any violation of the correct installation procedures may cause permanent damage to your mainboard.
5. Press the CPU down firmly into the socket and close the lever. As the CPU is likely to move while the lever is being closed, always close the lever with your fingers pressing tightly on top of the CPU to make sure the CPU is properly and completely embedded into the socket.

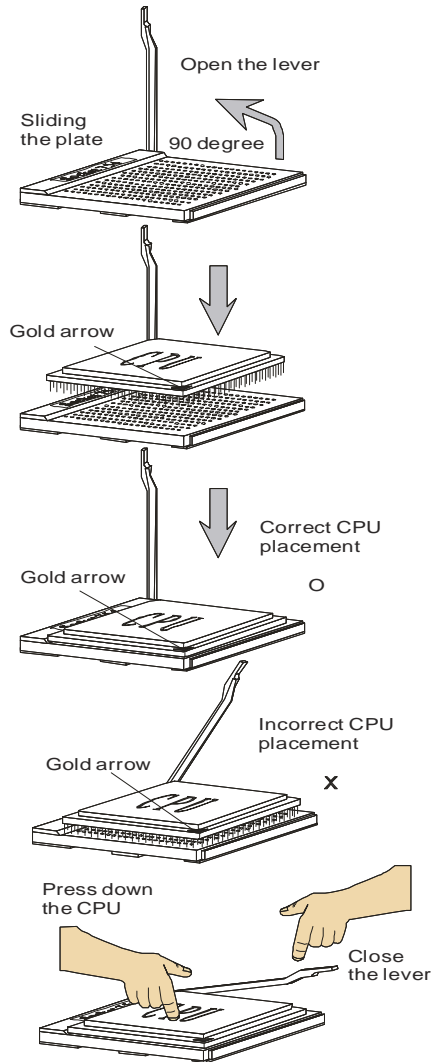

Installing CPU Cooler Set

When you are installing the CPU, make sure the CPU has a heat sink and a cooling fan attached on the top to prevent overheating. If you do not have the heat sink and cooling fan, contact your dealer to purchase and install them before turning on the computer.

1. Position the cooling set onto the retention mechanism. Hook one end of the clip to hook first.

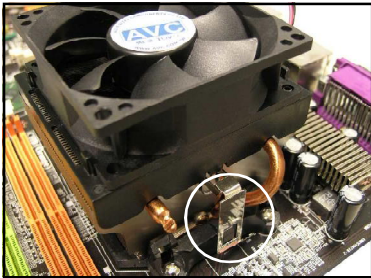

2. Then press down the other end of the clip to fasten the cooling set on the top of the retention mechanism. Locate the Fix Lever and lift up it .

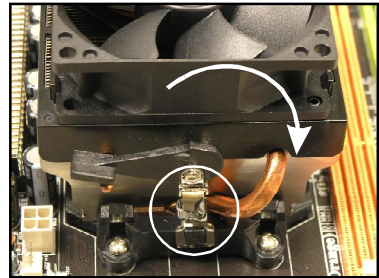

3. Fasten down the lever.

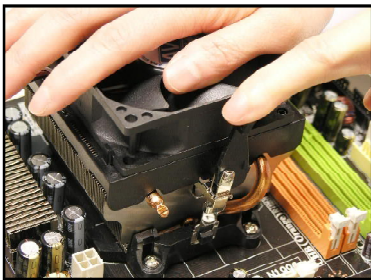

4. Attach the CPU Fan cable to the CPU fan connector on the mainboard.

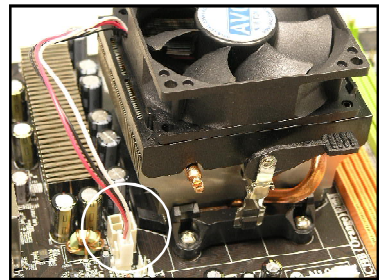

Important

Mainboard photos shown in this section are for demonstration of the CPU/ cooler installation only. The appearance of your mainboard may vary depending on the model you purchase.

Memory

These DIMM slots are intended for memory modules.

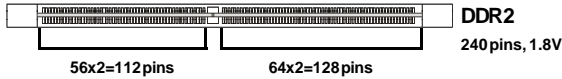

Dual-Channel Memory Population Rules

In Dual-Channel mode, the memory modules can transmit and receive data with two data bus lines simultaneously. Enabling Dual-Channel mode can enhance the system performance. Please refer to the following illustrations for population rules under Dual-Channel mode.

1



2



Installing Memory Modules

1. The memory module has only one notch on the center and will only fit in the right orientation.
2. Insert the memory module vertically into the DIMM slot. Then push it in until the golden finger on the memory module is deeply inserted in the DIMM slot. The plastic clip at each side of the DIMM slot will automatically close when the memory module is properly seated.



Important

You can barely see the golden finger if the memory module is properly inserted in the DIMM slot.

3. Manually check if the memory module has been locked in place by the DIMM slot clips at the sides.

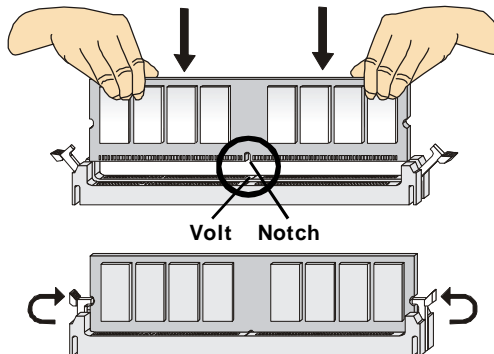

Important

1. In Dual-Channel mode, make sure that you install memory modules of the same type and density in different channel DIMM slots.
2. To enable successful system boot-up, always insert the memory modules into the DIMM1 first.
3. Due to the chipset resource deployment, the system density will only be detected up to 7+GB (not full 8GB) when each DIMM is installed with a 2GB memory module.

Power Supply

ATX 24-Pin Power Connector: ATXPWR1

This connector allows you to connect an ATX 24-pin power supply. To connect the ATX 24-pin power supply, make sure the plug of the power supply is inserted in the proper orientation and the pins are aligned. Then push down the power supply firmly into the connector. You may use the 20-pin ATX power supply as you like. If you'd like to use the 20-pin ATX power supply, please plug your power supply along with pin 1 & pin 13 (refer to the image at the right hand).

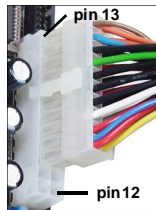

There is also a foolproof design on pin 11, 12, 23 & 24 to avoid wrong installation.

Pin Definition

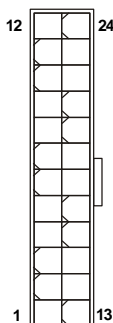

ATXPWR1

PIN	SIGNAL	PIN	SIGNAL
1	+3.3V	13	+3.3V
2	+3.3V	14	-12V
3	GND	15	GND
4	+5V	16	PS-ON#
5	GND	17	GND
6	+5V	18	GND
7	GND	19	GND
8	PWROK	20	Res
9	5VSB	21	+5V
10	+12V	22	+5V
11	+12V	23	+5V
12	+3.3V	24	GND

ATX 12V Power Connector: PWR1

This power connector is used to provide power to the CPU.



PWR1

Pin Definition

PIN	SIGNAL
1	GND
2	GND
3	12V
4	12V



Important

1. Make sure that all the connectors are connected to proper power supplies to ensure stable operation of the mainboard.
2. Power supply of 350 watts (and above) is highly recommended for system stability.

Back Panel

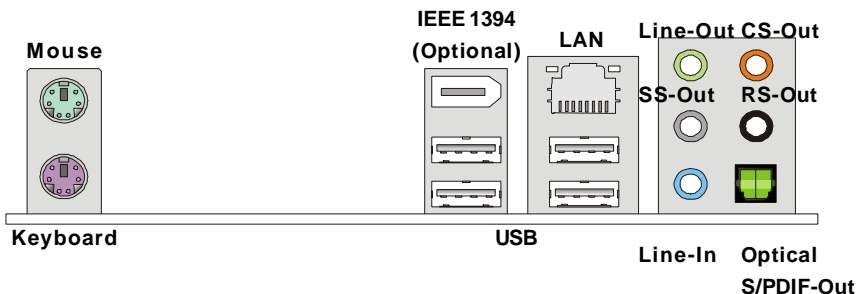

► Mouse/ Keyboard

The standard PS/2® mouse/keyboard DIN connector is for a PS/2® mouse/keyboard.

► IEEE 1394 Port

The 1394 port on the back panel provides connection to 1394 devices.

► USB Port

The USB (Universal Serial Bus) port is for attaching USB devices such as keyboard, mouse, or other USB-compatible devices.

► LAN

The standard RJ-45 LAN jack is for connection to Local Area Network (LAN). You can connect a network cable to it.



LED	Color	LED State	Condition
Left	Green	Off	LAN link is not established.
		On (steady state)	LAN link is established.
		On (brighter & pulsing)	The computer is communicating with another computer on the LAN.
Right	Green	Off	10 Mbit/sec data rate is selected.
		On	100 Mbit/sec data rate is selected.
	Orange	On	1000 Mbit/sec data rate is selected.

► Audio Ports

These audio connectors are used for audio devices. You can differentiate the color of the audio jacks for different audio sound effects.

- **Line-Out (Green)** - Line Out, is a connector for speakers or headphones.
- **SS-Out (Gray)** - Side-Surround Out 7.1 channel mode.
- **Line-In (Blue)** - Line In, is used for external CD player, tape player or other audio devices.
- **CS-Out (Orange)** - Center/ Subwoofer Out in 5.1/ 7.1 channel mode.
- **RS-Out (Black)** - Rear-Surround Out in 4/ 5.1/ 7.1 channel mode.
- **Optical S/PDIF-Out** - This S/PDIF (Sony & Philips Digital Interconnect Format) connector is provided for digital audio transmission to external speakers through an optical fiber cable.

Connector

Floppy Disk Drive Connector: FDD1

This connector supports 360KB, 720KB, 1.2MB, 1.44MB or 2.88MB floppy disk drive.

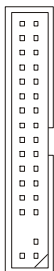

FDD1

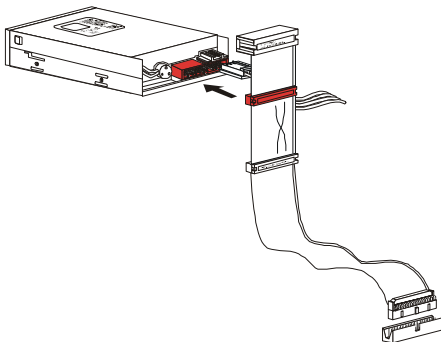

IDE Connector: IDE1

This connector supports IDE hard disk drives, optical disk drives and other IDE devices.

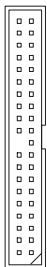

IDE1

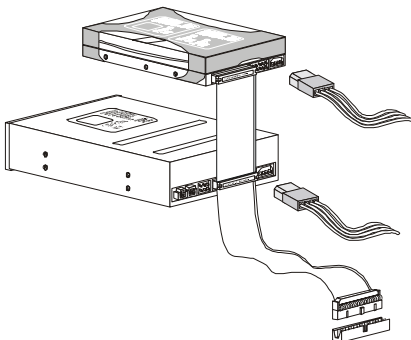

Important

If you install two IDE devices on the same cable, you must configure the drives separately to master / slave mode by setting jumpers. Refer to IDE device's documentation supplied by the vendors for jumper setting instructions.

SPI Flash ROM Connector: JSPI1

This connector is used to flash SPI flash ROM.



Pin Definition

Pin	Description	Pin	Description
1	VCC3_SB	2	VCC3_SB
3	SPI_MISO_F	4	SPI_MOSI_F
5	SPI_CS0_F#	6	SPI_CLK_F
7	GND	8	GND
9	SPI_HOLD#	10	NC

Serial ATA Connector: SATA1~6

This connector is a high-speed Serial ATA interface port. Each connector can connect to one Serial ATA device.

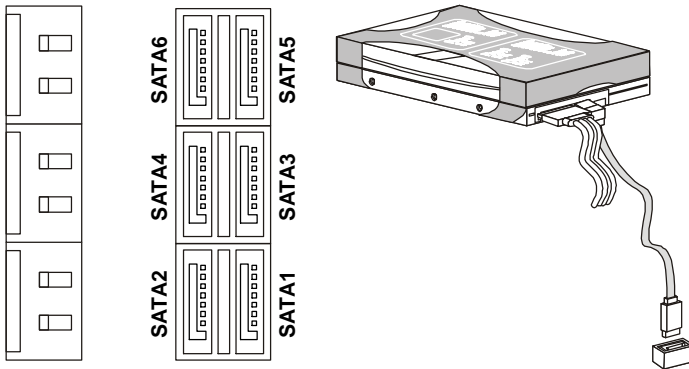

Important

Please do not fold the Serial ATA cable into 90-degree angle. Otherwise, data loss may occur during transmission.

Fan Power Connector: CPUFAN1

The fan power connectors support system cooling fan with +12V. When connecting the wire to the connectors, always note that the red wire is the positive and should be connected to the +12V; the black wire is Ground and should be connected to GND. If the mainboard has a System Hardware Monitor chipset onboard, you must use a specially designed fan with speed sensor to take advantage of the CPU fan control.

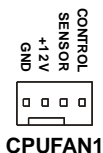

Important

1. Please refer to the recommended CPU fans at processor's official website or consult the vendors for proper CPU cooling fan.
2. CPUFAN1 supports fan control. You can activate the Smart Fan function in the BIOS Setup Utility to automatically control the CPU fan speed according to the actual CPU temperature.
3. Fan/heatsink with 3 or 4 pins are both available for CPUFAN1.

CD-In Connector: JCD1

This connector is provided for external audio input.

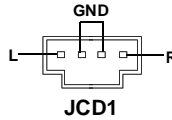

Front Panel Audio Connector: JAUD1

This connector allows you to connect the front panel audio and is compliant with Intel® Front Panel I/O Connectivity Design Guide.

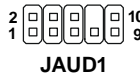

HD Audio Pin Definition

PIN	SIGNAL	DESCRIPTION
1	MIC_L	Microphone - Left channel
2	GND	Ground
3	MIC_R	Microphone - Right channel
4	NC	No control
5	LINEout_R	Analog Port - Right channel
6	MIC_JD	Jack detection return from front panel microphone JACK1
7	Front_JD	Jack detection sense line from the High Definition Audio CODEC jack detection resistor network
8	NC	No control
9	LINE out_L	Analog Port - Left channel
10	LINEout_JD	Jack detection return from front panel JACK2

S/PDIF-Out Connector: SPDOUT1

This connector is used to connect S/PDIF (Sony & Philips Digital Interconnect Format) interface for digital audio transmission.

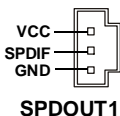

Front USB Connector: JUSB1~3

This connector, compliant with Intel® I/O Connectivity Design Guide, is ideal for connecting high-speed USB interface peripherals such as USB HDD, digital cameras, MP3 players, printers, modems and the like.



Pin Definition

PIN	SIGNAL	PIN	SIGNAL
1	VCC	2	VCC
3	USB0-	4	USB1-
5	USB0+	6	USB1+
7	GND	8	GND
9	Key (no pin)	10	USBOC



Important

Note that the pins of VCC and GND must be connected correctly to avoid possible damage.

Front Panel Connectors: JFP1

The mainboard provides one front panel connector for electrical connection to the front panel switches and LEDs. JFP1 is compliant with Intel® Front Panel I/O Connectivity Design Guide.



Pin Definition

PIN	SIGNAL	DESCRIPTION
1	PS_ON	Power Switch On (1)
2	PS_ON	Power Switch On (2)
3	PWR_LED	PowerLED (+)
4	PWR_LED	PowerLED (-)
5	HDD_LED	HDD LED (-)
6	HDD_LED	HDD LED(+)
7	Reset	Reset (1)
8	Reset	Reset (2)

IEEE 1394 Connector: J1394_1 (Optional)

This connector allows you to connect the IEEE 1394 device via an optional IEEE 1394 bracket.



Pin Definition

PIN	SIGNAL	PIN	SIGNAL
1	TPA+	2	TPA-
3	Ground	4	Ground
5	TPB+	6	TPB-
7	Cable power	8	Cable power
9	Key (no pin)	10	Ground

SCART Output Connector: JSCA1

This connector allows you to connect the output device with SCART spec. SCART is the established European standard for connecting home video equipments like TVs, VCRs, DVD players, etc.

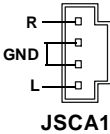

Front LCD Module Connector: JVFD1

This connector allows you to connect to Medion VFD LCD panel.

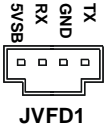

Jumper

Clear CMOS Jumper: JBAT1

There is a CMOS RAM onboard that has a power supply from an external battery to keep the data of system configuration. With the CMOS RAM, the system can automatically boot OS every time it is turned on. If you want to clear the system configuration, set the jumper to clear data.



Important

You can clear CMOS by shorting 2-3 pin while the system is off. Then return to 1-2 pin position. Avoid clearing the CMOS while the system is on; it will damage the mainboard.

Slot

PCI (Peripheral Component Interconnect) Express Slot

The PCI Express slot supports the PCI Express interface expansion card. The PCI Express x16 slot supports up to 4.0 GB/s transfer rate. The PCI Express x1 slot supports up to 250 MB/s transfer rate.

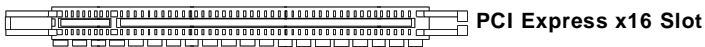

PCI (Peripheral Component Interconnect) Slot

The PCI slot supports LAN card, SCSI card, USB card, and other add-on cards that comply with PCI specifications.



Important

When adding or removing expansion cards, make sure that you unplug the power supply first. Meanwhile, read the documentation for the expansion card to configure any necessary hardware or software settings for the expansion card, such as jumpers, switches or BIOS configuration.

PCI Interrupt Request Routing

The IRQ, acronym of interrupt request line and pronounced I-R-Q, are hardware lines over which devices can send interrupt signals to the microprocessor. The PCI IRQ pins are typically connected to the PCI bus pins as follows:

	Order 1	Order 2	Order 3	Order 4
PCI Slot 1	INT B# INT C#	INT C# INT D#	INT D# INT A#	INT A# INT B#
PCI Slot 2	INT A#	INT B#	INT C#	INT D#