

MS-7358 series

MS-7358 (v1.X) Mainboard

Copyright Notice

The material in this document is the intellectual property of the company. We take every care in the preparation of this document, but no guarantee is given as to the correctness of its contents. Our products are under continual improvement and we reserve the right to make changes without notice.

Trademarks

All trademarks are the properties of their respective owners.

NVIDIA, the NVIDIA logo, DualNet, and nForce are registered trademarks or trademarks of NVIDIA Corporation in the United States and/or other countries.

AMD, Athlon™, Athlon™ XP, Thoroughbred™, and Duron™ are registered trademarks of AMD Corporation.

Intel® and Pentium® are registered trademarks of Intel Corporation.

PS/2 and OS®/2 are registered trademarks of International Business Machines Corporation.

Windows® 95/98/2000/NT/XP/ Vista are registered trademarks of Microsoft Corporation.

Netware® is a registered trademark of Novell, Inc.

Award® is a registered trademark of Phoenix Technologies Ltd.

AMI® is a registered trademark of American Megatrends Inc.

Revision History

Revision	Revision History	Date
V1.0	First release for PCB 1.X	June 2007

Technical Support

If a problem arises with your system and no solution can be obtained from the user's manual, please contact your place of purchase or local distributor. Alternatively, please try the following help resources for further guidance.

Safety Instructions

1. Always read the safety instructions carefully.
2. Keep this User's Manual for future reference.
3. Keep this equipment away from humidity.
4. Lay this equipment on a reliable flat surface before setting it up.
5. The openings on the enclosure are for air convection hence protects the equipment from overheating. **DO NOT COVER THE OPENINGS.**
6. Make sure the voltage of the power source and adjust properly 110/220V before connecting the equipment to the power inlet.
7. Place the power cord such a way that people can not step on it. Do not place anything over the power cord.
8. Always Unplug the Power Cord before inserting any add-on card or module.
9. All cautions and warnings on the equipment should be noted.
10. Never pour any liquid into the opening that could damage or cause electrical shock.
11. If any of the following situations arises, get the equipment checked by a service personnel:
 - † The power cord or plug is damaged.
 - † Liquid has penetrated into the equipment.
 - † The equipment has been exposed to moisture.
 - † The equipment has not work well or you can not get it work according to User's Manual.
 - † The equipment has dropped and damaged.
 - † The equipment has obvious sign of breakage.
12. **DO NOT LEAVE THIS EQUIPMENT IN AN ENVIRONMENT UNCONDITIONED, STORAGE TEMPERATURE ABOVE 60°C (140°F), IT MAY DAMAGE THE EQUIPMENT.**



CAUTION: Danger of explosion if battery is incorrectly replaced. Replace only with the same or equivalent type recommended by the manufacturer.



警告使用者:

這是甲類的資訊產品，在居住的環境中使用時，可能會造成無線電干擾，在這種情況下，使用者會被要求採取某些適當的對策。



廢電池請回收

For better environmental protection, waste batteries should be collected separately for recycling or special disposal.

FCC-B Radio Frequency Interference Statement

This equipment has been tested and found to comply with the limits for a Class B digital device, pursuant to Part



15 of the FCC Rules. These limits are designed to provide reasonable protection against harmful interference in a residential installation. This equipment generates, uses and can radiate radio frequency energy and, if not installed and used in accordance with the instructions, may cause harmful interference to radio communications. However, there is no guarantee that interference will not occur in a particular installation. If this equipment does cause harmful interference to radio or television reception, which can be determined by turning the equipment off and on, the user is encouraged to try to correct the interference by one or more of the measures listed below.

- † Reorient or relocate the receiving antenna.
- † Increase the separation between the equipment and receiver.
- † Connect the equipment into an outlet on a circuit different from that to which the receiver is connected.
- † Consult the dealer or an experienced radio/television technician for help.

Notice 1

The changes or modifications not expressly approved by the party responsible for compliance could void the user's authority to operate the equipment.

Notice 2

Shielded interface cables and A.C. power cord, if any, must be used in order to comply with the emission limits.

VOIR LANOTICE D'INSTALLATIONAVANT DE RACCORDER AU RESEAU.



This device complies with Part 15 of the FCC Rules. Operation is subject to the following two conditions:

- (1) this device may not cause harmful interference, and*
- (2) this device must accept any interference received, including interference that may cause undesired operation.*

CONTENTS

Copyright Notice	ii
Trademarks	ii
Revision History	ii
Technical Support	ii
Safety Instructions	iii
FCC-B Radio Frequency Interference Statement	iv
Chapter 1. Getting Started	1-1
Mainboard Specifications	1-2
Mainboard Layout	1-4
Chapter 2. Hardware Setup	2-1
Quick Components Guide	2-2
CPU (Central Processing Unit)	2-3
Memory	2-7
Power Supply	2-9
Back Panel	2-10
Connectors	2-12
Jumper	2-19
Slots	2-20

Chapter 1

Getting Started

Thank you for choosing the MS-7358 Series Micro-ATX mainboard. The MS-7358 Series mainboards are based on **Intel® G33 & ICH9R** chipsets for optimal system efficiency. Designed to fit the advanced **Intel® Core 2 Quad/Core 2 Duo/ Dual-Core LGA775** processor, the MS-7358 Series deliver a high performance and professional desktop platform solution.

Mainboard Specifications

Processor Support

- Intel® Core 2 Quad/Core 2 Duo/Dual-Core processors in the LGA775 package

Supported FSB

- 1333/ 1066/ 800 MHz

Chipset

- North Bridge: Intel® G33 chipset
- South Bridge: Intel® ICH9R chipset

Memory Support

- DDR2 800/667 SDRAM (8GB Max)
- 4 DDR2 DIMMs (240pin / 1.8V)

LAN

- Supports PCIE LAN 10/100/1000 Fast Ethernet by Intel 82566

Audio

- Chip integrated by Realtek® ALC888
- Flexible 8-channel audio with jack sensing
- Compliant with Azalia 1.0 Spec
- Meet Microsoft Vista Premium spec

IDE

- 1 IDE port by Marvell 88SE6111
- Supports Ultra DMA 66/100/133 mode
- Supports PIO, Bus Master operation mode

SATA

- 6 SATAII ports by ICH9R (2 eSATA)
- 1 SATA II port by Marvell 88SE6111
- Supports storage and data transfers at up to 300 MB/s

RAID

- Supports Intel Matrix Storage Technology (RAID 0/1) by ICH9R

1394

- Supports 1394 by VIA VT6308

FDD

- 1 floppy port
- Supports 1 FDD with 360KB, 720KB, 1.2MB, 1.44MB and 2.88MB

Connectors

- **Back panel**
 - 1 PS/2 mouse port
 - 1 PS/2 keyboard port
 - 2 eSATA ports (support Command Based Port Multipliers)
 - 6 USB 2.0 Ports
 - 1 LAN jack (10/100/1000)
 - 6 flexible audio jacks
 - 1 1394 port
 - 1 VGA Port
- **On-Board Pinheaders / Connectors**
 - 3 USB 2.0 pinheaders
 - 1 1394 pinheader
 - 1 SPDIF-out pinheader
 - 1 CD-in connector
 - 1 front audio pinheader
 - 1 VFD connector

Slots

- 1 PCI Express x16 slot
- 1 PCI Express x1 slots
- 1 PCI white slot, support 3.3V/ 5V PCI bus Interface, support 1 device
- 1 PCI blue slot, support 3.3V/ 5V PCI bus interface, support 2 devices

Form Factor

- Micro-ATX (24.5cm X 24.5cm)

Mounting

- 8 mounting holes

Mainboard Layout

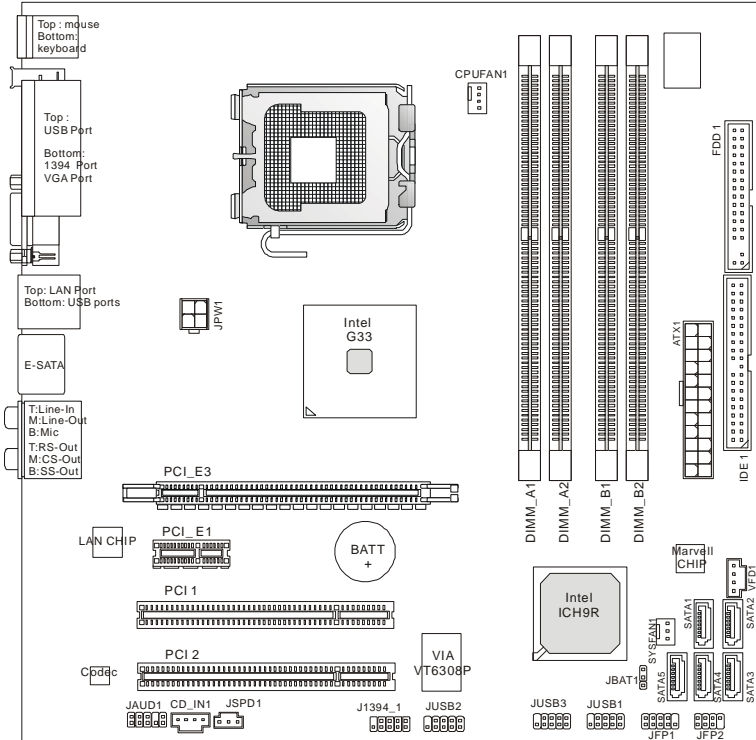

**MS-7358 Series
(MS-7358 v1.X) Micro-ATX Mainboard**

Chapter 2

Hardware Setup

This chapter provides you with the information about hardware setup procedures. While doing the installation, be careful in holding the components and follow the installation procedures. For some components, if you install in the wrong orientation, the components will not work properly.

Use a grounded wrist strap before handling computer components. Static electricity may damage the components.

Quick Components Guide

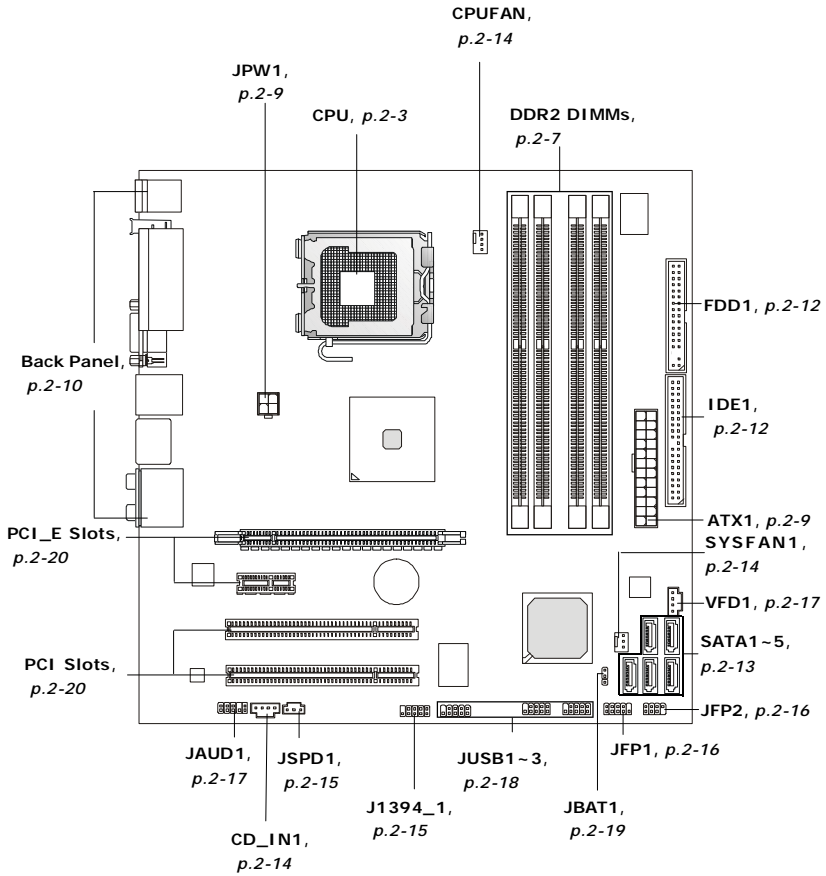

CPU (Central Processing Unit)

When you are installing the CPU, **make sure to install the cooler to prevent overheating.** If you do not have the CPU cooler, consult your dealer before turning on the computer.



Important

Overheating

Overheating will seriously damage the CPU and system. Always make sure the cooling fan can work properly to protect the CPU from overheating. Make sure that you apply an even layer of thermal paste (or thermal tape) between the CPU and the heatsink to enhance heat dissipation.

Replacing the CPU

While replacing the CPU, always turn off the ATX power supply or unplug the power supply's power cord from the grounded outlet first to ensure the safety of CPU.

Overclocking

*This mainboard is designed to support overclocking. However, please make sure your components are able to tolerate such abnormal setting, while doing overclocking. Any attempt to operate beyond product specifications is not recommended. **We do not guarantee the damages or risks caused by inadequate operation or beyond product specifications.***

Introduction to LGA 775 CPU

The pin-pad side of LGA 775 CPU.

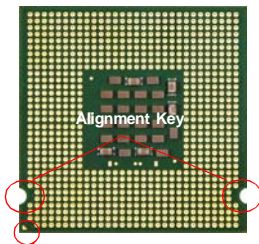

Yellow triangle is the Pin 1 indicator

The surface of LGA 775 CPU. Remember to apply some thermal paste on it for better heat dispersion.

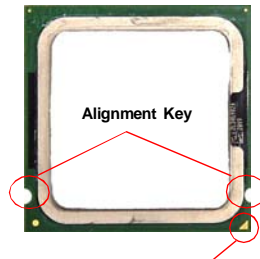

Yellow triangle is the Pin 1 indicator

CPU & Cooler Installation

When you are installing the CPU, **make sure the CPU has a cooler attached on the top to prevent overheating.** Meanwhile, do not forget to apply some thermal paste on CPU before installing the heat sink/cooler fan for better heat dispersion. Follow the steps below to install the CPU & cooler correctly. Wrong installation will cause the damage of your CPU & mainboard.

1. The CPU socket has a plastic cap on it to protect the contact from damage. Before you install the CPU, always cover it to protect the socket pin.
2. Remove the cap from lever hinge side (as the arrow shows).

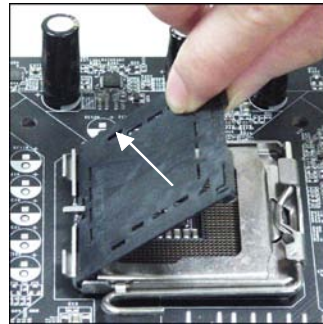
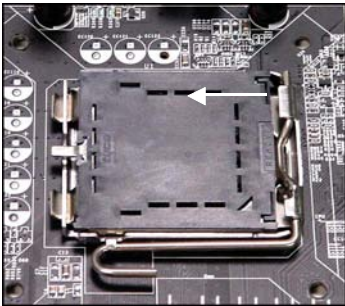

3. The pins of socket reveal.
4. Open the load lever.

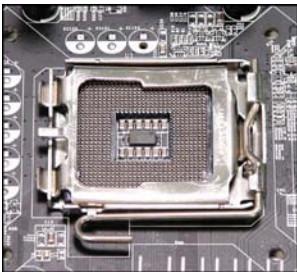

Important

1. Confirm if your CPU cooler is firmly installed before turning on your system.
2. Do not touch the CPU socket pins to avoid damaging.
3. The availability of the CPU land side cover depends on your CPU packing.

Hardware Setup

5. Lift the load lever up and open the load plate.

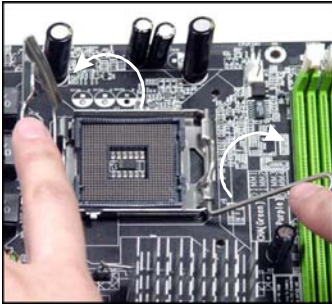

6. After confirming the CPU direction for correct mating, put down the CPU in the socket housing frame. Be sure to grasp on the edge of the CPU base. Note that the alignment keys are matched.

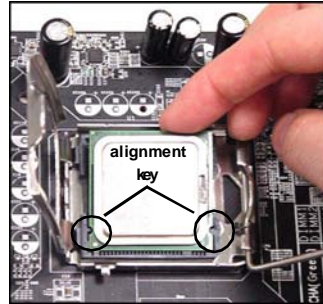

7. Visually inspect if the CPU is seated well into the socket. If not, take out the CPU with pure vertical motion and reinstall.



8. Cover the load plate onto the package.



MS-7358 Mainboard

9. Press down the load lever lightly onto the load plate, and then secure the lever with the hook under retention tab.



10. Align the holes on the mainboard with the heatsink. Push down the cooler until its four clips get wedged into the holes of the mainboard.

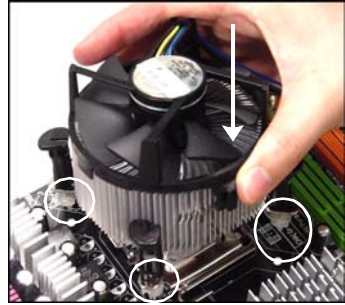

11. Press the four hooks down to fasten the cooler. Then rotate the locking switch (refer to the correct direction marked on it) to lock the hooks.

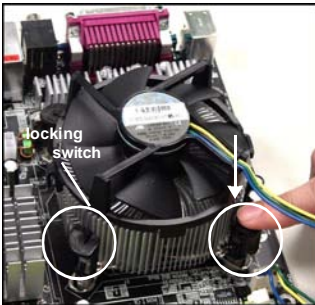

12. Turn over the mainboard to confirm that the clip-ends are correctly inserted.

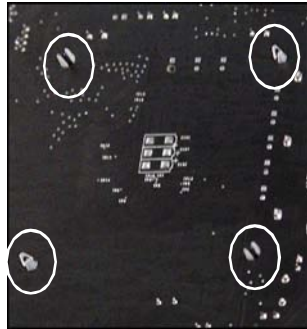

Important

1. Read the CPU status in BIOS (Chapter 3).
2. Whenever CPU is not installed, always protect your CPU socket pin with the plastic cap covered (shown in Figure 1) to avoid damaging.
3. Mainboard photos shown in this section are for demonstration of the CPU/cooler installation only. The appearance of your mainboard may vary depending on the model you purchase.

Memory

These DIMM slots are used for installing memory modules.

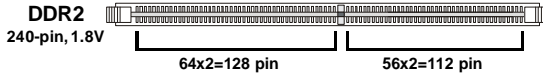

Dual-Channel mode Population Rule

In Dual-Channel mode, the memory modules can transmit and receive data with two data bus lines simultaneously. Enabling Dual-Channel mode can enhance the system performance. Please refer to the following illustrations for population rules under Dual-Channel mode.

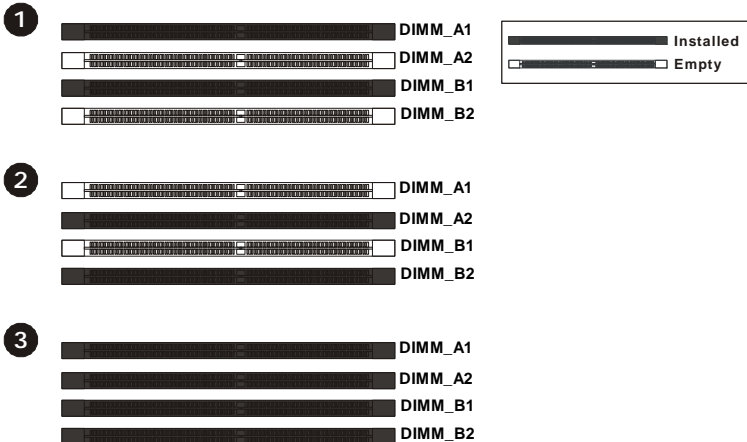

Installing Memory Modules

1. The memory module has only one notch on the center and will only fit in the right orientation.
2. Insert the memory module vertically into the DIMM slot. Then push it in until the golden finger on the memory module is deeply inserted in the DIMM slot.



Important

You can barely see the golden finger if the memory module is properly inserted in the DIMM slot.

3. The plastic clip at each side of the DIMM slot will automatically close.

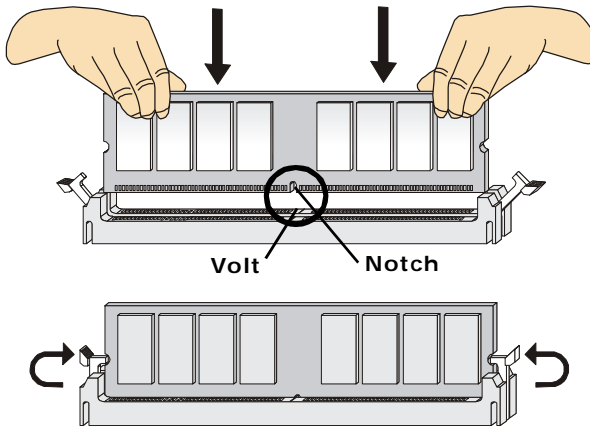

Important

- DDR2 memory modules are not interchangeable with DDR and the DDR2 standard is not backwards compatible. You should always install DDR2 memory modules in the DDR2 DIMM slots.
- In Dual-Channel mode, make sure that you install memory modules of **the same type and density** in different channel DIMM slots.
- To enable successful system boot-up, always insert the memory modules into the **DIMM_A1** first.

Power Supply

ATX 24-Pin Power Connector: ATX1

This connector allows you to connect an ATX 24-pin power supply. To connect the ATX 24-pin power supply, make sure the plug of the power supply is inserted in the proper orientation and the pins are aligned. Then push down the power supply firmly into the connector.

You may use the 20-pin ATX power supply as you like. If you'd like to use the 20-pin ATX power supply, please plug your power supply along with pin 1 & pin 13 (refer to the image at the right hand).



ATX1		Pin Definition			
PIN	SIGNAL	PIN	SIGNAL		
1	+3.3V	13	+3.3V		
2	+3.3V	14	-12V		
3	GND	15	GND		
4	+5V	16	PS-ON#		
5	GND	17	GND		
6	+5V	18	GND		
7	GND	19	GND		
8	PWR OK	20	Res		
9	5VSB	21	+5V		
10	+12V	22	+5V		
11	+12V	23	+5V		
12	+3.3V	24	GND		

ATX 12V Power Connector: JPW1

This 12V power connector JPW1 is used to provide power to the CPU.

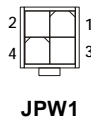

Pin Definition

PIN	SIGNAL
1	GND
2	GND
3	12V
4	12V



Important

1. Make sure that all the connectors are connected to proper ATX power supplies to ensure stable operation of the mainboard.
2. Power supply of 350 watts (and above) is highly recommended for system stability.

Back Panel

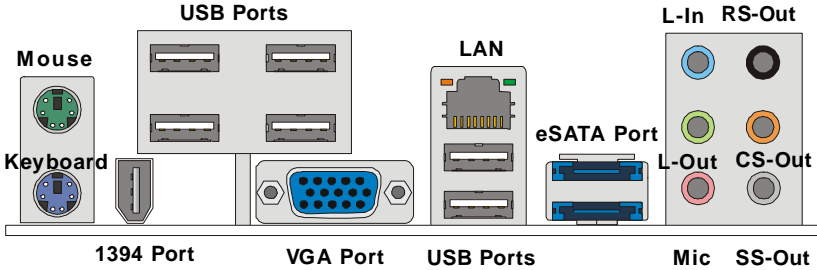

► Mouse/Keyboard

The standard PS/2[®] mouse/keyboard DIN connector is for a PS/2[®] mouse/keyboard.

► VGA Port

The DB15-pin female connector is provided for monitor.

► 1394 Port (Optional)

The IEEE1394 port on the back panel provides connection to IEEE1394 devices.

► USB Port

The USB (Universal Serial Bus) port is for attaching USB devices such as keyboard, mouse, or other USB-compatible devices.

► LAN

The standard RJ-45 LAN jack is for connection to the Local Area Network (LAN). You can connect a network cable to it.

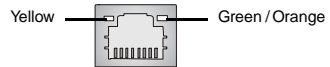

LED	Color	LED State	Condition
Left	Yellow	Off	LAN link is not established.
		On (steady state)	LAN link is established.
		On (brighter & pulsing)	The computer is communicating with another computer on the LAN.
Right	Green	Off	10 Mbit/sec data rate is selected.
		On	100 Mbit/sec data rate is selected.
	Orange	On	1000 Mbit/sec data rate is selected.

► Audio Ports

These audio connectors are used for audio devices. You can differentiate the color of the audio jacks for different audio sound effects.

- **Line-In (Blue)** - Line In is used for external CD player, tapeplayer or other audio devices.
- **Line-Out (Green)** - Line Out, is a connector for speakers or headphones.
- **Mic (Pink)** - Mic, is a connector for microphones.
- **RS-Out (Black)** - Rear-Surround Out in 4/ 5.1/ 7.1 channel mode.
- **CS-Out (Orange)** - Center/ Subwoofer Out in 5.1/ 7.1 channel mode.
- **SS-Out (Gray)** - Side-Surround Out 7.1 channel mode.

► eSATA Port

The eSATA port is for attaching the eSATA external hard drive.

Connectors

Floppy Disk Drive Connector: FDD1

This connector supports 360KB, 720KB, 1.2MB, 1.44MB or 2.88MB floppy disk drive.

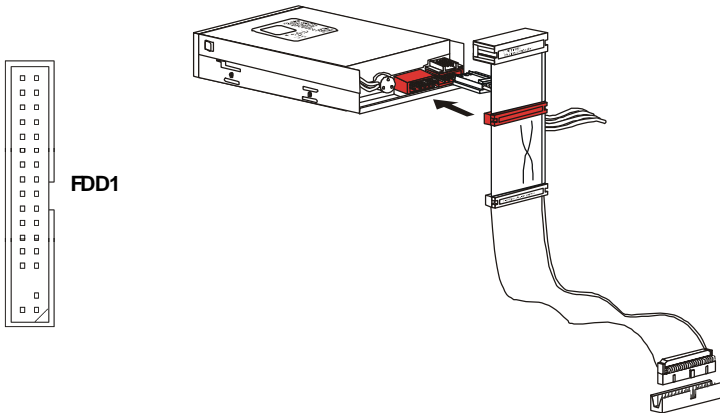

IDE Connector: IDE1

This connector supports IDE hard disk drives, optical disk drives and other IDE devices.

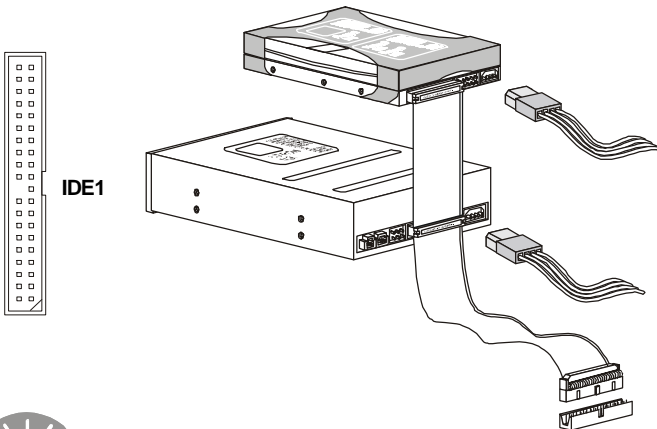

Important

If you install two IDE devices on the same cable, you must configure the drives separately to master / slave mode by setting jumpers. Refer to IDE device's documentation supplied by the vendors for jumper setting instructions.

Serial ATA Connector: SATA1 ~ SATA5

This connector is a high-speed Serial ATA interface port. Each connector can connect to one Serial ATA device.

SATA2
supported by Marvell 88SE6111

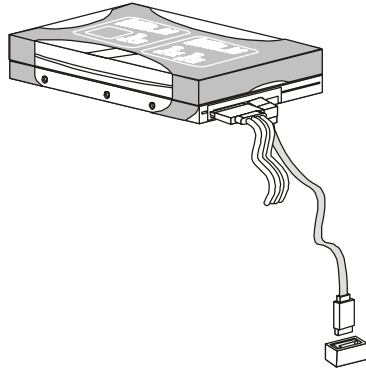
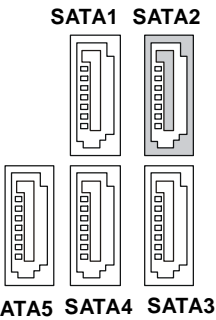

SATA1/3/4/5 supported by ICH9R



Important

Please do not fold the Serial ATA cable into 90-degree angle. Otherwise, data loss may occur during transmission.

Fan Power Connectors: CPUFAN, SYSFAN1

The fan power connectors support system cooling fan with +12V. When connecting the wire to the connectors, always note that the red wire is the positive and should be connected to the +12V; the black wire is Ground and should be connected to GND. If the mainboard has a System Hardware Monitor chipset on-board, you must use a specially designed fan with speed sensor to take advantage of the CPU fan control.

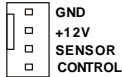

CPUFAN1

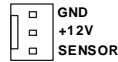

SYSFAN1



Important

1. Please refer to the recommended CPU fans at processor's official website or consult the vendors for proper CPU cooling fan.
2. Fan cooler set with 3 or 4 pins power connector are both available for CPUFAN1.

CD-In Connector: CD_IN1

This connector is provided for external audio input.

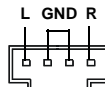

CD_IN1

IEEE1394 Connector: J1394_1

This connector allows you to connect the IEEE1394 device via an optional IEEE1394 bracket.

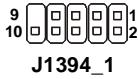

Pin Definition

PIN	SIGNAL	PIN	SIGNAL
1	TPA+	2	TPA-
3	Ground	4	Ground
5	TPB+	6	TPB-
7	Cable power	8	Cable power
9	Key (no pin)	10	Ground

S/PDIF-Out Connector: JSPD1

This connector is used to connect S/PDIF (Sony & Philips Digital Interconnect Format) interface for digital audio transmission.

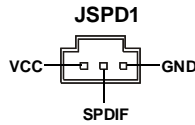

Front Panel Connectors: JFP1, JFP2

These connectors are for electrical connection to the front panel switches and LEDs. The JFP1 is compliant with Intel® Front Panel I/O Connectivity Design Guide.

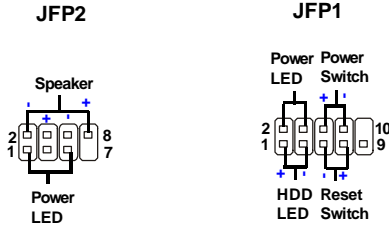

JFP1 Pin Definition

PIN	SIGNAL	DESCRIPTION
1	HD_LED +	Hard disk LED pull-up
2	FPPWR/SLP	MSG LED pull-up
3	HD_LED -	Hard disk active LED
4	FPPWR/SLP	MSG LED pull-up
5	RST_SW -	Reset Switch low reference pull-down to GND
6	PWR_SW+	Power Switch high reference pull-up
7	RST_SW +	Reset Switch high reference pull-up
8	PWR_SW-	Power Switch low reference pull-down to GND
9	RSVD_DNU	Reserved. Do not use.

JFP2 Pin Definition

PIN	SIGNAL	DESCRIPTION
1	GND	Ground
2	SPK-	Speaker-
3	SLED	SuspendLED
4	BUZ+	Buzzer+
5	PLED	PowerLED
6	BUZ-	Buzzer-
7	NC	No connection
8	SPK+	Speaker+

Front Panel Audio Connector: JAUD1

This connector allows you to connect the front panel audio and is compliant with Intel® Front Panel I/O Connectivity Design Guide.



HD Audio Pin Definition

PIN	SIGNAL	DESCRIPTION
1	MIC_L	Microphone - Left channel
2	GND	Ground
3	MIC_R	Microphone - Right channel
4	PRESENCE#	Active low signal-signals BIOS that a High Definition Audio dongle is connected to the analog header. PRESENCE# = 0 when a High Definition Audio dongle is connected
5	LINE out_R	Analog Port - Right channel
6	MIC_JD	Jack detection return from front panel microphone JACK1
7	Front_JD	Jack detection sense line from the High Definition Audio CODEC jack detection resistor network
8	NC	No control
9	LINE out_L	Analog Port - Left channel
10	LINE out_JD	Jack detection return from front panel JACK2

Front LCD Module Connector: VFD1

This connector allows you to connect to Medion VFD LCD panel.

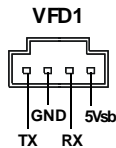

Front USB Connector: JUSB1 ~ 3

These connectors, compliant with Intel® I/O Connectivity Design Guide, is ideal for connecting high-speed USB interface peripherals such as **USB HDD, digital cameras, MP3 players, printers, modems and the like.**

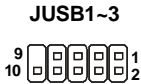

Pin Definition

PIN	SIGNAL	PIN	SIGNAL
1	VCC	2	VCC
3	USB0-	4	USB1-
5	USB0+	6	USB1+
7	GND	8	GND
9	Key (no pin)	10	USBOC



Important

Note that the pins of VCC and GND must be connected correctly to avoid possible damage.

Jumper

Clear CMOS Jumper: JBAT1

There is a CMOS RAM onboard that has a power supply from an external battery to keep the data of system configuration. With the CMOS RAM, the system can automatically boot OS every time it is turned on. If you want to clear the system configuration, set the jumper to clear data.

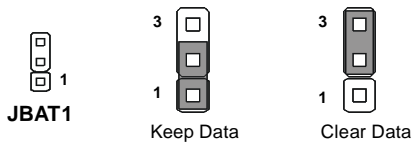

Important

You can clear CMOS by shorting 2-3 pin while the system is off. Then return to 1-2 pin position. Avoid clearing the CMOS while the system is on; it will damage the mainboard.

Slots

PCI (Peripheral Component Interconnect) Express Slot

The PCI Express slot supports the PCI Express interface expansion card.
 The PCI Express x 16 slot supports up to 4.0 GB/s transfer rate.
 The PCI Express x 4 slot supports up to 1.0 GB/s transfer rate.
 The PCI Express x 1 slot supports up to 250 MB/s transfer rate.

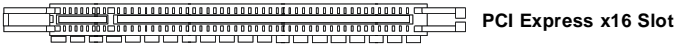

PCI (Peripheral Component Interconnect) Slot

The PCI slot supports LAN card, SCSI card, USB card, and other add-on cards that comply with PCI specifications.

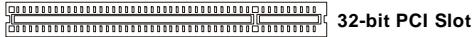

Important

When adding or removing expansion cards, make sure that you unplug the power supply first. Meanwhile, read the documentation for the expansion card to configure any necessary hardware or software settings for the expansion card, such as jumpers, switches or BIOS configuration.

PCI Interrupt Request Routing

The IRQ, acronym of interrupt request line and pronounced I-R-Q, are hardware lines over which devices can send interrupt signals to the microprocessor. The PCI IRQ pins are typically connected to the PCI bus pins as follows:

	Order 1	Order 2	Order 3	Order 4
PCI Slot 1	INT A#	INT B#	INT C#	INT D#
PCI Slot 2	INT B#	INT C#	INT D#	INT A#
	INT C#	INT D#	INT A#	INT B#